

Service
Service
Service



Service Manual

TABLE OF CONTENTS

	Page
Location of PCBs.....	1-2
Specifications	1-3
Measurement Setup	1-4
Service Aids, Safety Instruction, etc	1-5
CD Playability Check.....	1-6 to 1-7
Software Version Checking	2
Set Wiring & Block Diagram	3
Main & Tuner & Headphone Boards.....	4
MCU & USB Board.....	5
Display & Key Board	6
Set Mechanical Exploded View & Parts List.....	7
Revision List	8



© Copyright 2009 Philips Consumer Electronics B.V. Eindhoven, The Netherlands
 All rights reserved. No part of this publication may be reproduced, stored in a retrieval system or transmitted, in any form or by any means, electronic, mechanical, photocopying, or otherwise without the prior permission of Philips.

Published by SL 0920 Service Audio

Printed in The Netherlands

Subject to modification

© 3141 785 34140

Version 1.0



PHILIPS

PCBS LOCATION

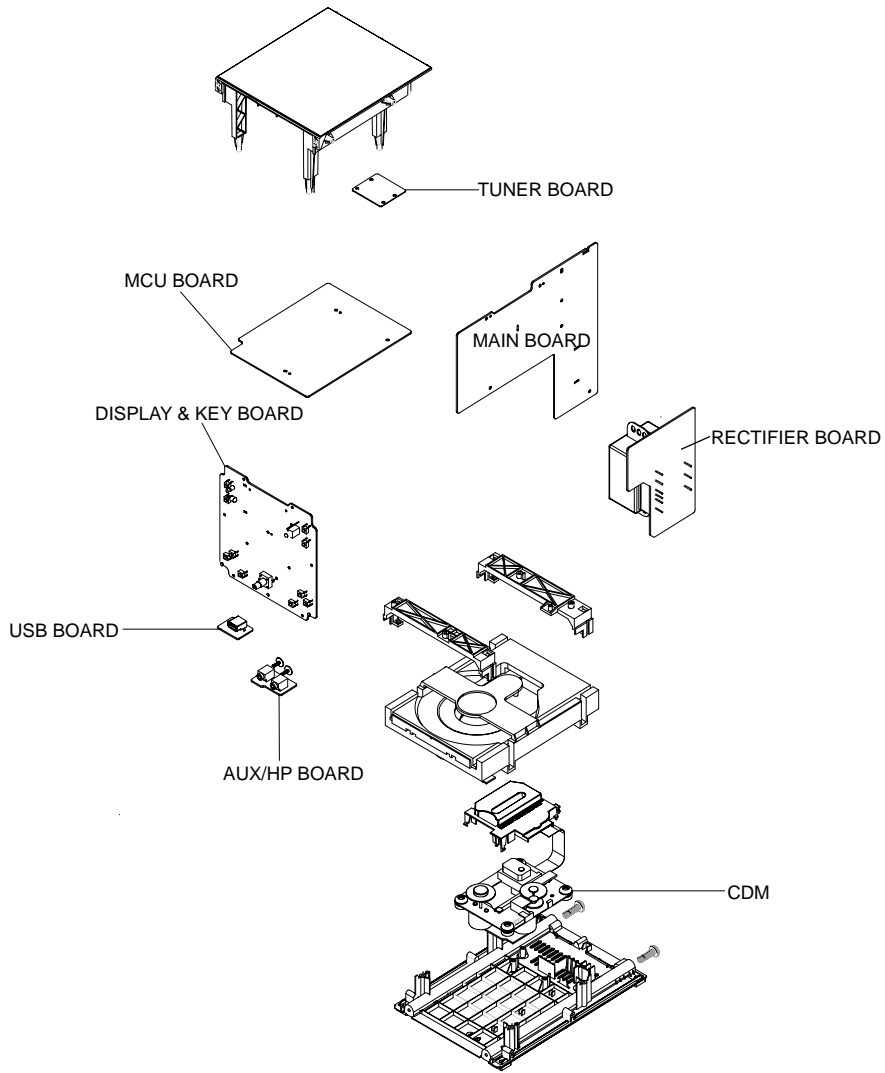

VERSION VARIATIONS

Board in used:	Type /Versions:	MCM305									
	Service policy	/12	/05	/37	/55	/58	/61				/98
MAIN BOARD	C/M										
MCU BOARD	C/M										
USB JACK BOARD	C										
DISPLAY & KEY BOARD	C										
TUNER BOARD	M										
HEADPHONE BOARD	C										
RECTIFIER BOARD	M										

* TIPS : C -- Component Lever Repair.
 M -- Module Lever Repair
 x -- Used

SOFTWARE VERSION CHECKING

- 1) MCU version : at CD mode and No CD, press and hold "PLAY" & "DBB" buttons more than 5 seconds at the same time, the display will show the version of MCU, e.g. "CD-042 MCU-017".
- 2) While displaying MCU software version, to turn VOLUME knob can show full display pattern for Key Founction Test,

MCU & USB BOARD

TABLE OF CONTENTS

MCU Board Layout Top View	5-2
MCU Board Layout Bottom View	5-3
USB Jack Board Layout Diagram.....	5-4
Circuit Diagram.....	5-5

PCB LAYOUT - MCU BOARD (TOP VIEW)

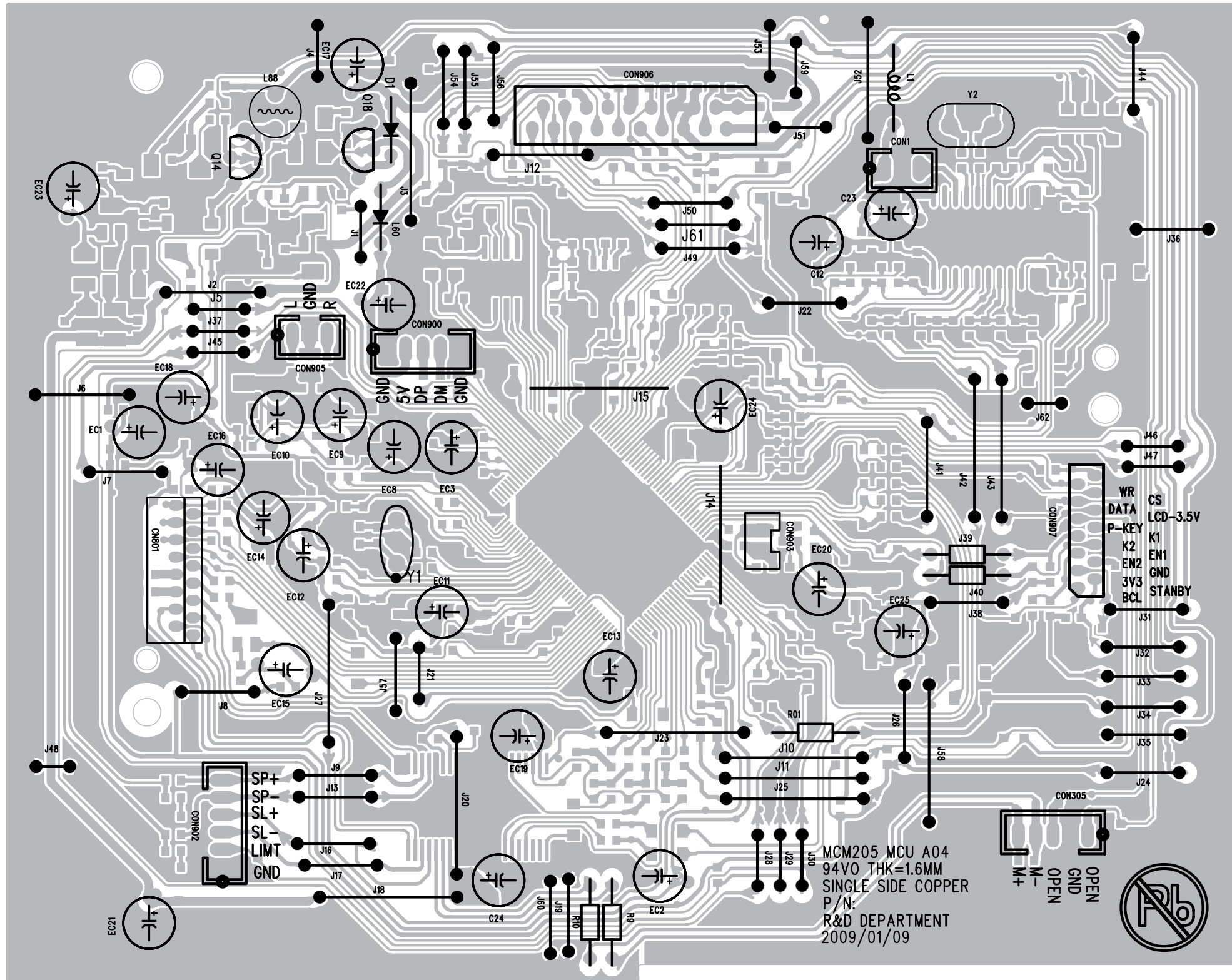

PCB LAYOUT - MCU BOARD (BOTTOM VIEW)

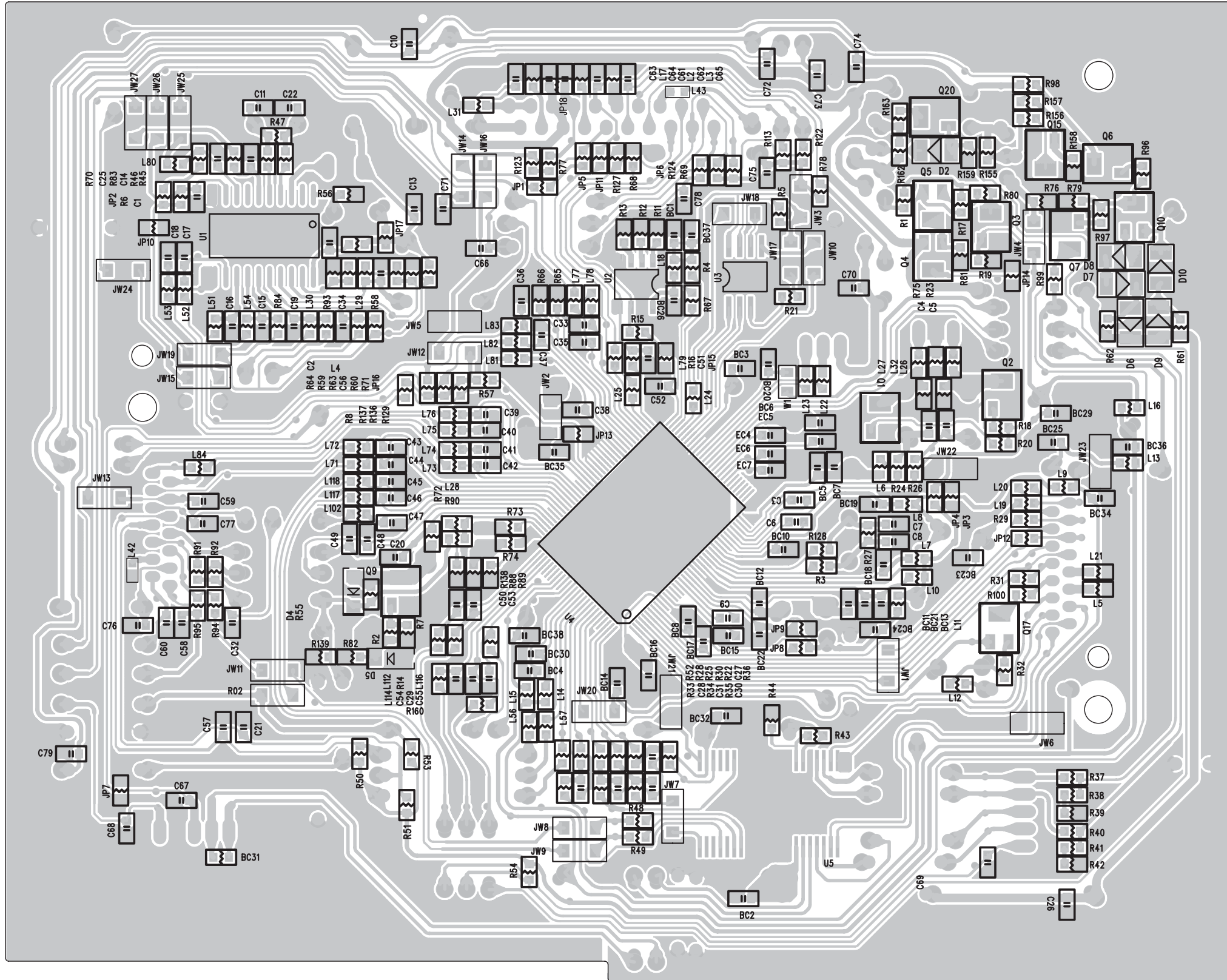

LAYOUT DIAGRAM - USB BOARD

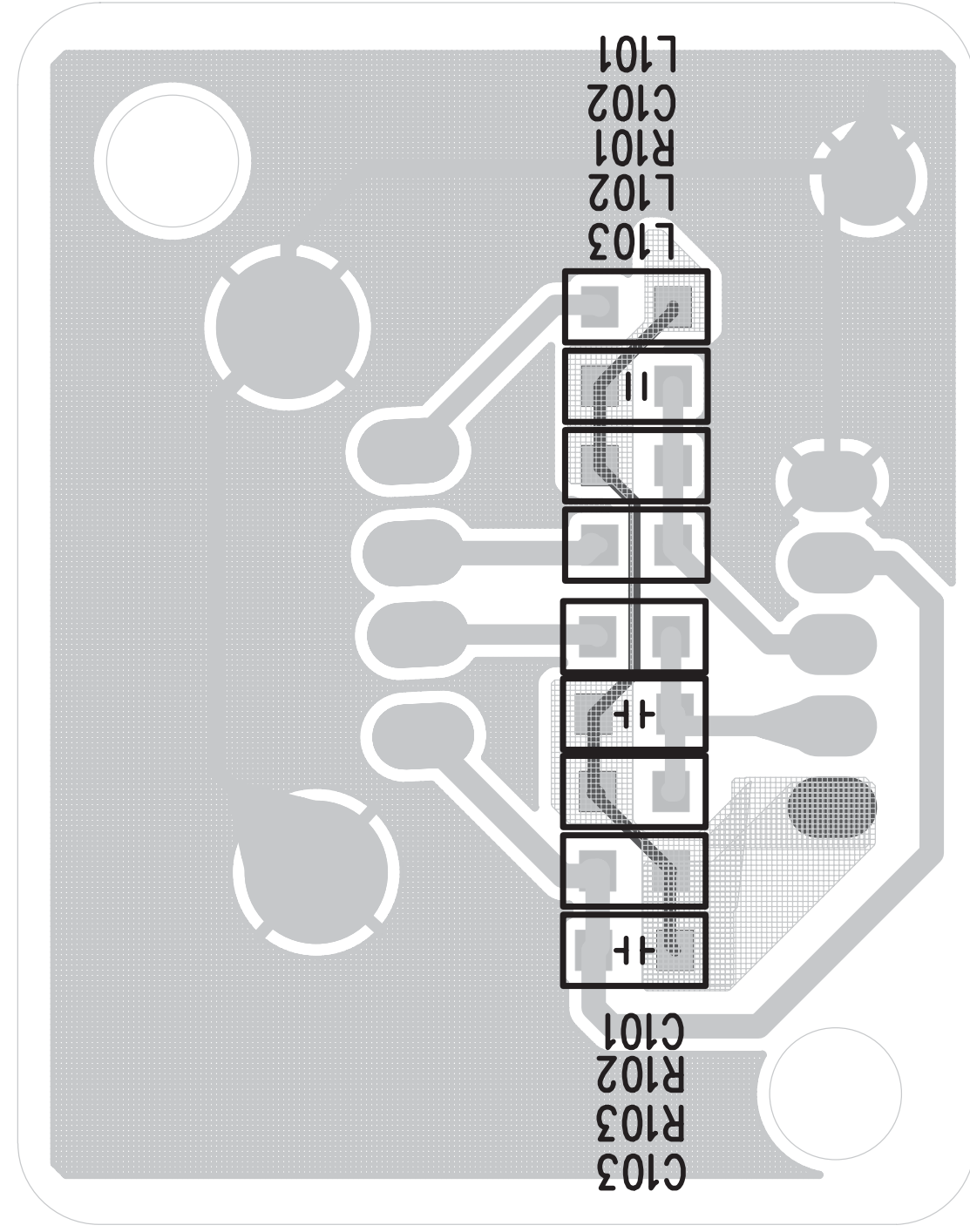
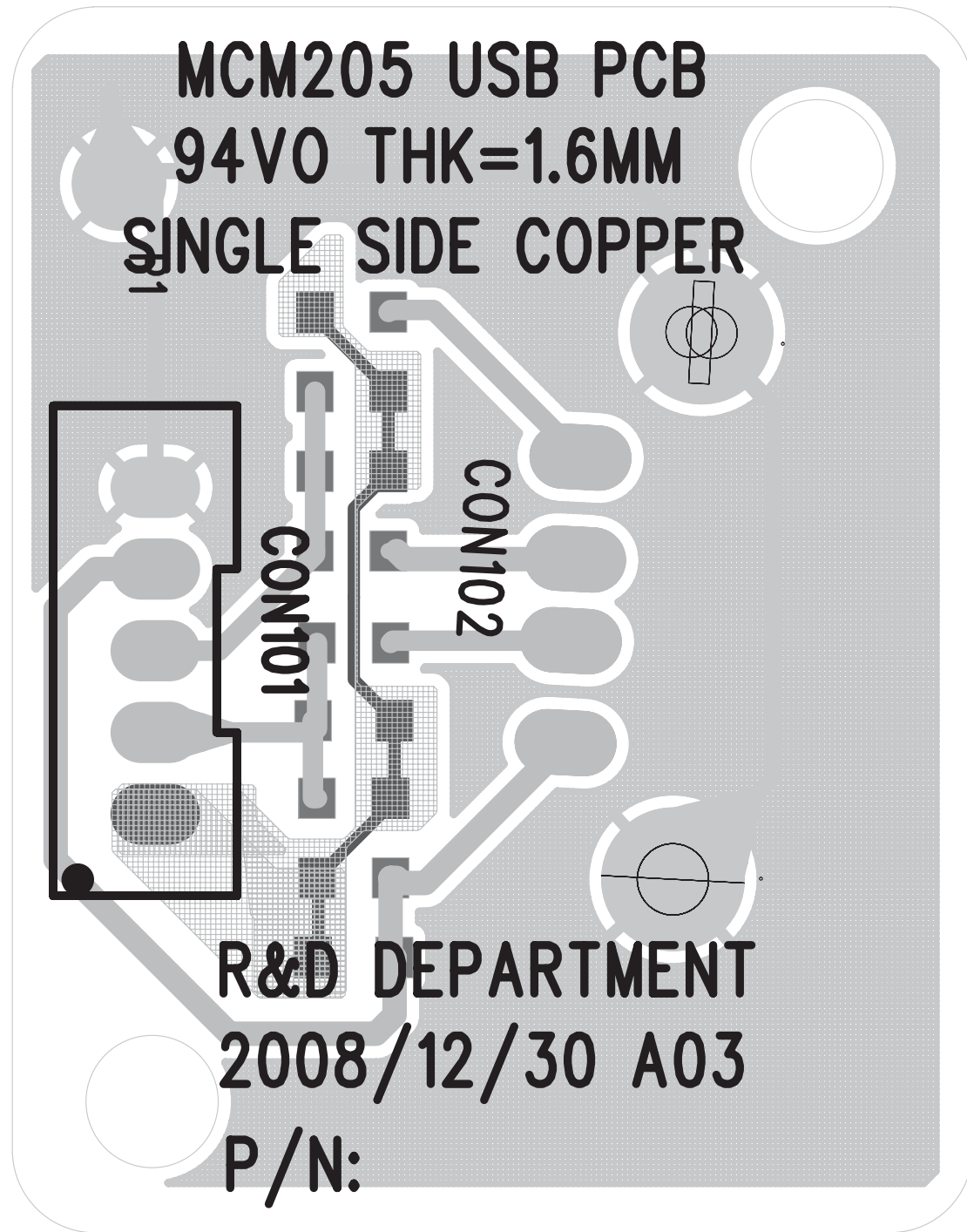

CIRCUIT DIAGRAM - MCU & USB BOARD

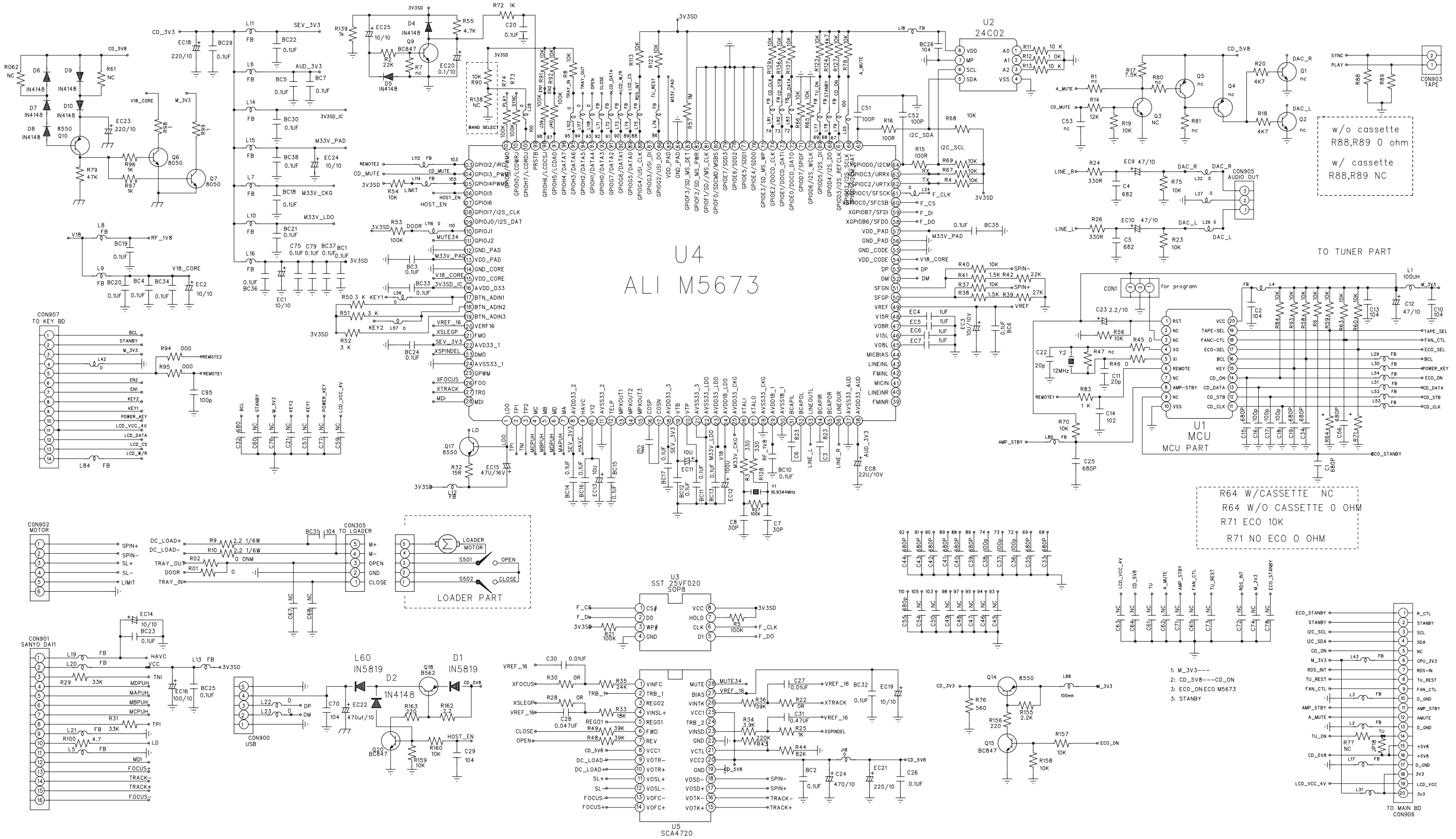

U4
ALI M5673

w/o cassette
R88,R89 0 ohm
w/ cassette
R88,R89 NC

R64 W/CASSETTE NC
R64 W/O CASSETTE 0 OHM
R71 ECO 10K
R71 NO ECO 0 OHM

- 1: M_3V3---
- 2: CD_5V8---CD_ON
- 3: ECO_ON ECO M5673
- 3: STANBY

TO MAIN BD
CON906

TO TUNER PART

LOADER PART

U5
SCA4720

DISPLAY/KEY BOARD

TABLE OF CONTENTS

Layout Top View	6-2
Layout Bottom View.....	6-3
Circuit Diagram.....	6-4

PCB LAYOUT - DISPLAY/KEY BOARD (TOP VIEW)

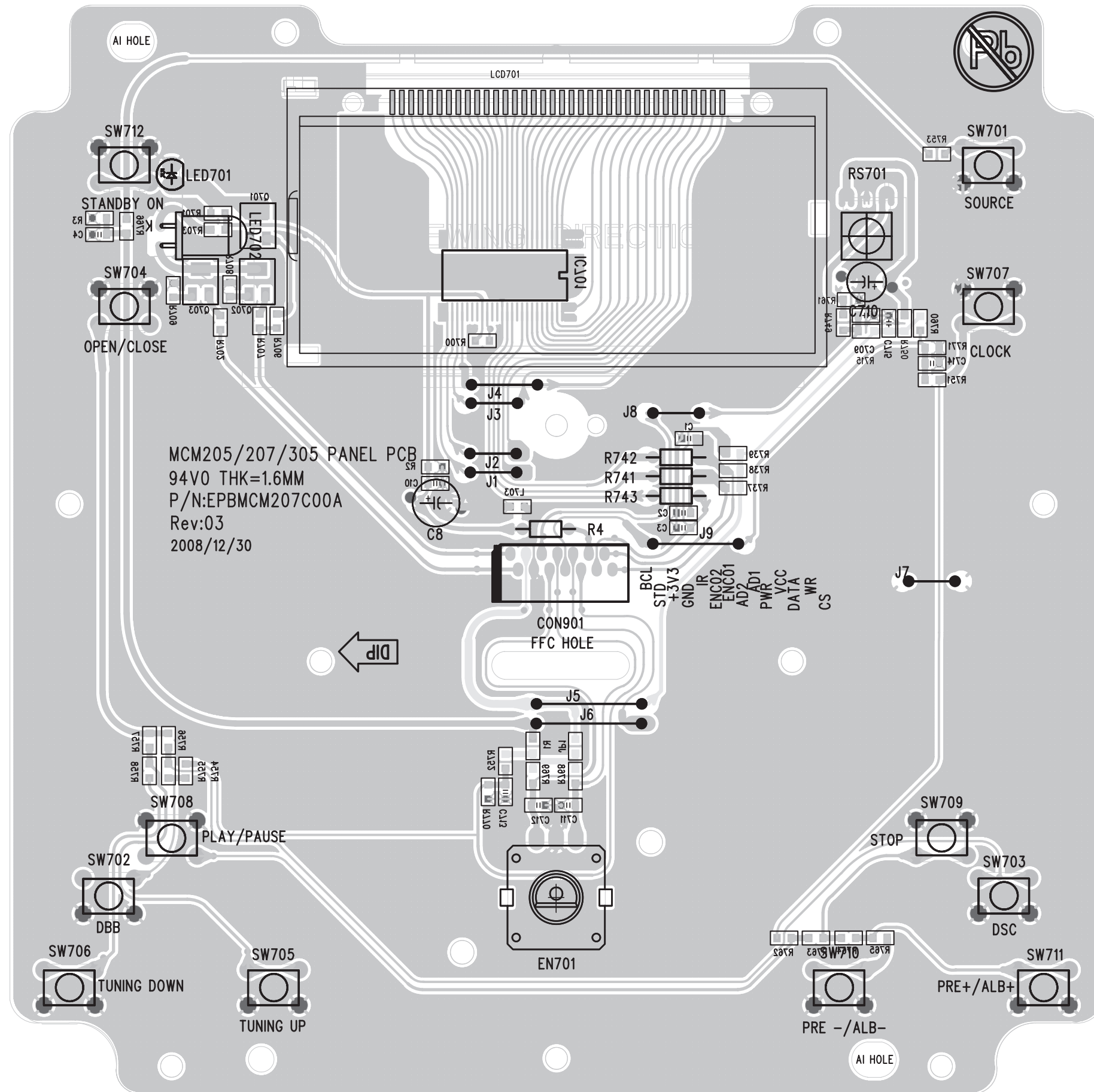

PCB LAYOUT - DISPLAY/KEY BOARD (BOTTOM VIEW)

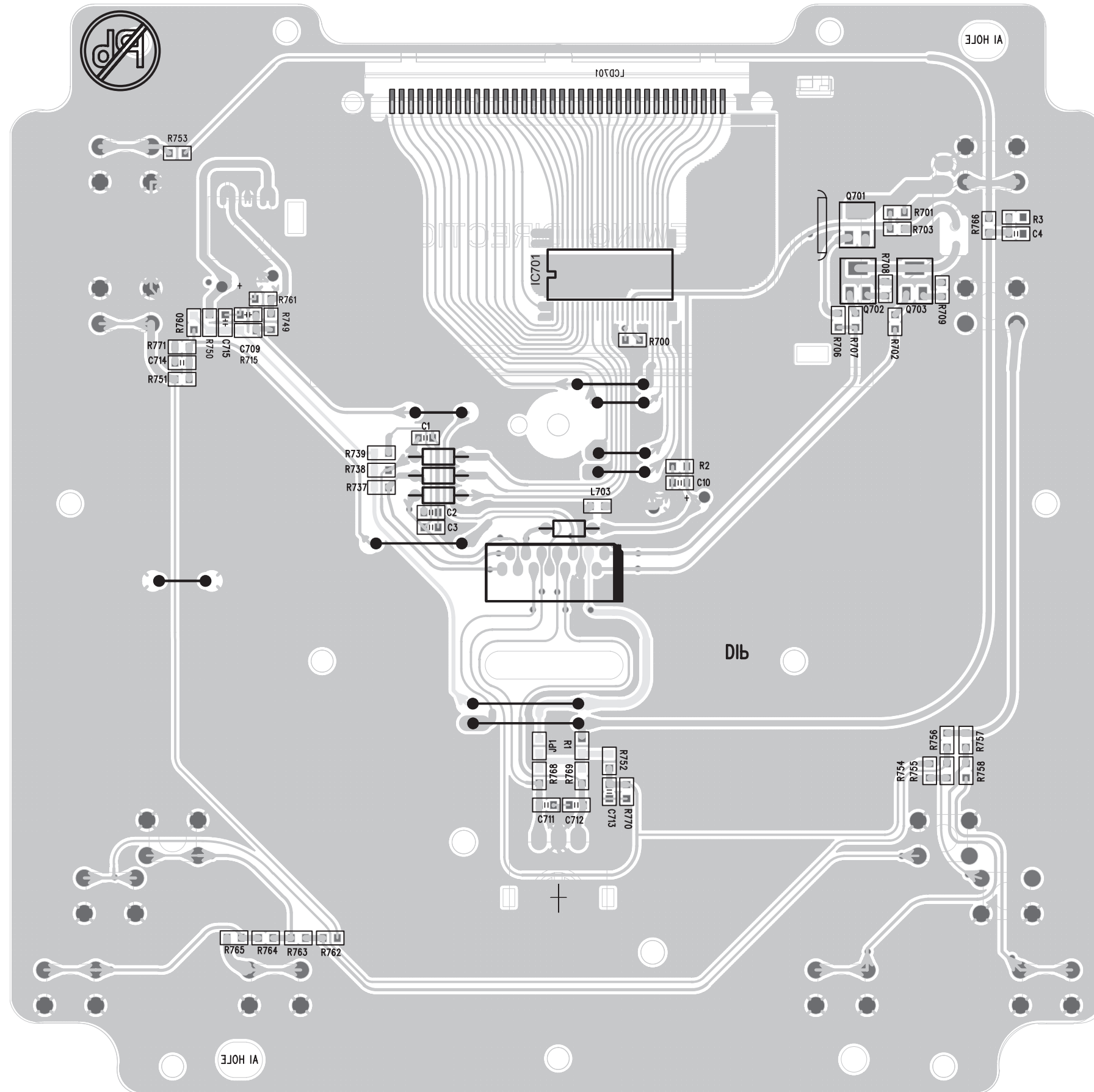

CIRCUIT DIAGRAM - DISPLAY/KEY BOARD

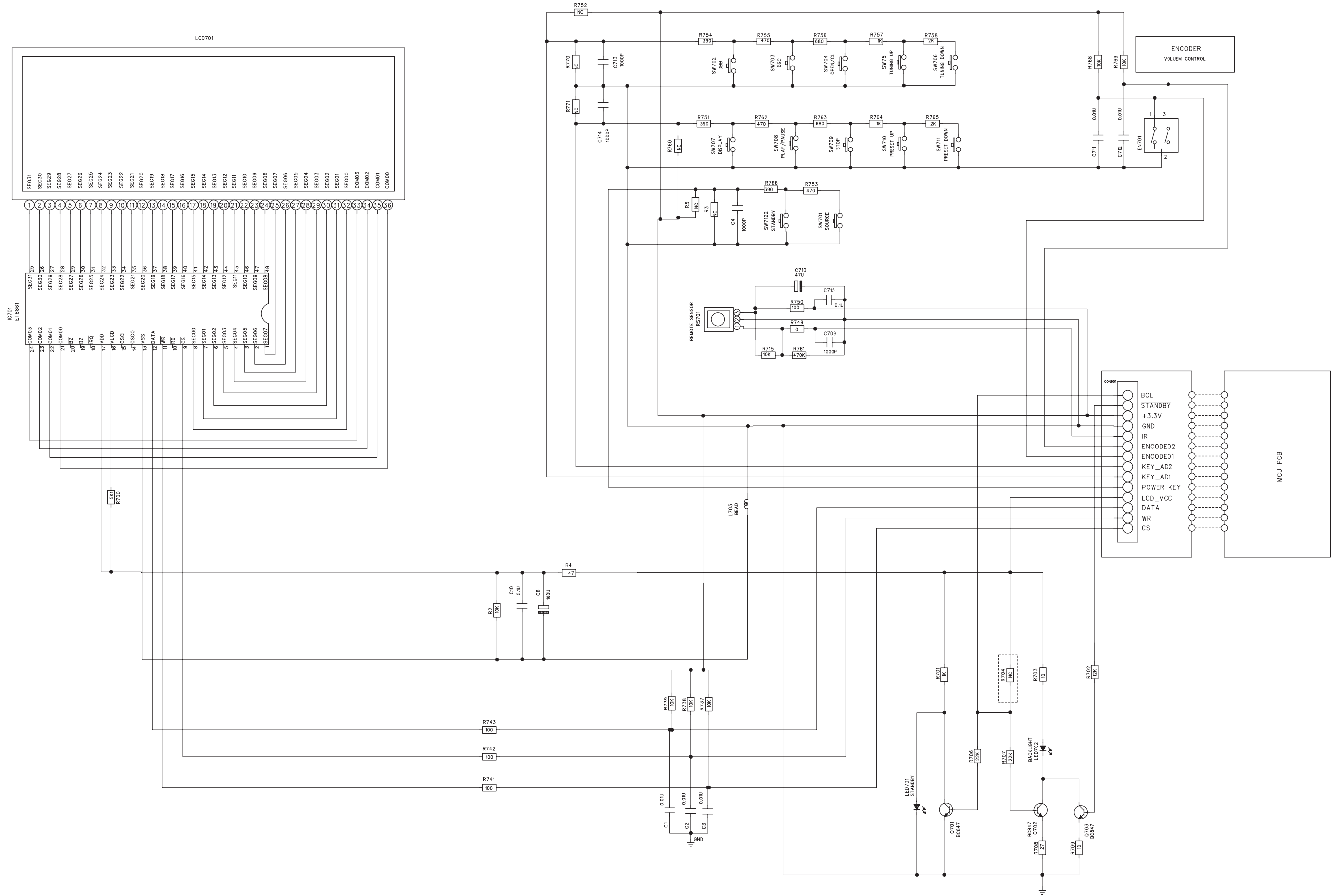

MECHANICAL & ACCESSORIES PARTS LIST

Loc.	12NC	Description
MAIN UNIT		
1	996510021657	VOLUME KNOB
2	996510025775	CD DOOR
3	996510025779	DISPLAY LENS
4	996510025776	PRSET ALBUM BUTTON
5	996510025783	DSC BUTTON
6	996510025788	STOP BUTTON
7	996510021658	FUNCTION BUTTON BKT LEFT
8	996510025792	FRONT CABINET
9	996510021666	SOURCE CLOCK BUTTON
10	996510025789	USB DOOR
11	996510025774	USB SPRING DIM:0.3MM
12	996520035756	USB BRACKET
13	996510025785	H.P. & AUX PCB
15	996520035749	CD PCB BRACKET - FRONT
16	996510025772	BOTTOM CABINET
17	994000005786	CD MECHANISM DA11VF(SANYO)
17A	996510000868	CD DAMPER PINK 658F HARDNESS
19	996510000871	CD TRAY LOADER
20	996510025115	CD PCB BRACKET - REAR
22	996510025777	USB PCB
23	996510025787	AC WIRE COVER
29	996510025784	REAR CABINET
30	996510025773	RECTIFIER PCB
34	996510025769	MAIN PCB
36	996510025781	TUNER PCB
37	996510012849	TOP CABINET
40	996510021678	MCM207 MCU PCB
44	996510012854	POWER LIGHT GUIDE
48	996510021656	POWER CD BUTTON
49	996510021663	FUNCTION BUTTON BKT RIGHT
50	996510025793	PLAY BUTTON
51	996510025778	DBB BUTTON
52	996510025786	TUNING BUTTON
A	△ 996510011350	POWER SUPPLY CORD 1720MM VDE
B	996510001906	AUX STEREO CORD
C	996510021665	REMOTE CONTROL
CON801I	996510025768	FFC CABLE 160MM 16P P1MM
CON907I	996510021686	FFC CABLE 80MM 14P P1MM
D	996510005595	PIG TAIL ANTENNA WIRE BLACK
E	996510025767	SPK BOX L+R
F	996510025105	AM BAR BRACKET
G	996510001074	CD SPRING DIM:0.5MM
H	996510001075	CD SPRING DIM:0.6MM

ELECTRICAL PARTS LIST

Loc.	12NC	Description
MCU PCB ASSY		
D1	996510011340	DIODE 1N5819 DO-41
D10	996510010774	DIODE 1N4148 FDLL4148
D2	996510010774	DIODE 1N4148 FDLL4148
D4	996510010774	DIODE 1N4148 FDLL4148
D5	996510010774	DIODE 1N4148 FDLL4148
D6	996510010774	DIODE 1N4148 FDLL4148
D7	996510010774	DIODE 1N4148 FDLL4148
D8	996510010774	DIODE 1N4148 FDLL4148
D9	996510010774	DIODE 1N4148 FDLL4148
J39	996520035757	CARBON RES. 100KR 1/6 W
J40	996520035757	CARBON RES. 100KR 1/6 W
L60	996510011340	DIODE 1N5819 DO-41
Q10	996510002323	TRANSISTOR S8550 SMD TYPE
Q14	996510002323	TRANSISTOR S8550 SMD TYPE
Q15	996510012793	TRANSISTOR BC847B
Q17	996510012833	TRANSISTOR BC857B
Q18	996510011342	TRANSISTOR HIT562 PNP TO-92MOD
Q20	996510012793	TRANSISTOR BC847B
Q3	996510012793	TRANSISTOR BC847B
Q6	996510016572	TRANSISTOR KTC8050S SOT-23
Q7	996510016572	TRANSISTOR KTC8050S SOT-23
Q9	996510012793	TRANSISTOR BC847B
R10	996520035758	CARBON RES. 2.2R 1/6 W
R9	996520035758	CARBON RES. 2.2R 1/6 W
U1	996510021671	IC MA802AS PROGRAMMED
U2	996510010763	IC AT24C02BN-SH-T
U3	996510021661	IC ST25VF040 PROGRAMMED
U4	996510021675	IC M5673 128P LQFP
U5	996510021673	IC SCA4720
Y2	996510016576	X'TAL 12MHZ 20PF +-20PPM
USB PCB ASSY		
CON102	996510001071	USB JACK 4P ANGLE TYPE
MAIN PCB ASSY		
C111	994000003218	ELECT. CAPACITOR 4700UF 35V
C115	994000003217	AL.E.CAP 3300UF 25V
C313	994000003218	ELECT. CAPACITOR 4700UF 35V
CON301	996510000380	PUSH TERMINAL JACK PST-418
D1	996510011340	DIODE 1N5819 DO-41
D10	996510010774	DIODE 1N4148 FDLL4148

MAIN PCB ASSY

D102	996510011332	DIODE 1N4148
D19	996510011332	DIODE 1N4148
D2	996510010774	DIODE 1N4148 FDLL4148
D212	996510011339	DIODE 1N4003
D303	996510011332	DIODE 1N4148
D4	996510010774	DIODE 1N4148 FDLL4148
D40	996510015965	DIODE 1N5401
D41	996510015965	DIODE 1N5401
D42	996510015965	DIODE 1N5401
D44	996510015965	DIODE 1N5401
D5	996510010774	DIODE 1N4148 FDLL4148
D6	996510010774	DIODE 1N4148 FDLL4148
D7	996510010774	DIODE 1N4148 FDLL4148
D8	996510010774	DIODE 1N4148 FDLL4148
D9	996510010774	DIODE 1N4148 FDLL4148
IC201	994000005724	I.C. LD1117AL-3.3V-D
IC202	996510001058	IC S7806PI TO-220F
IC301	994000003203	POWER AMPLIFIER IC TDA8947J
IC501	996510010771	IC 7314(ANGUS)
Q102	996510010767	TRANSISTOR 9015B TAPE FORM
Q15	996510024762	TRANSISTOR KTC9014S
Q17	996510012833	TRANSISTOR BC857B
Q20	996510024762	TRANSISTOR KTC9014S
Q203	994000001436	TRANSISTOR 2SB1566-F
Q205	996500039268	TRANSISTOR KTC-8050C
Q3	996500039268	TRANSISTOR KTC-8050C
Q501	996500039268	TRANSISTOR KTC-8050C
Q9	996510024762	TRANSISTOR KTC9014S
ZD1	996500039267	ZENER DIODE 3V9 1/2W
ZD101	994000005744	ZENER DIODE 5V1 1/2W
ZD201	996500039258	ZENER DIODE 9V1 1/2W
ZD203	996510011334	ZENER DIODE BZX4V7
ZD501	996510011338	DIODE BZX79-B8V2 SOD27

DISPLAY/KEY PCB ASSY

EN701	996510001059	ENCODER EC121102X2B-HA1-082
IC701	996510001064	IC ET8861S LCD DRIVER
LCD701	996510021695	LCD DISPLAY
Q15	996510012793	TRANSISTOR BC847B
Q20	996510012793	TRANSISTOR BC847B
Q3	996510012793	TRANSISTOR BC847B
R741	996510021674	CARBON RES. 100R 1/6W J%
R742	996510021674	CARBON RES. 100R 1/6W J%

ELECTRICAL PARTS LIST

Loc.	12NC	Description
------	------	-------------

DISPLAY/KEY PCB ASSY

R743	996510021674	CARBON RES. 100R 1/6W J%
R808	996510021669	CARBON RES. 47R 1/6W J%
RS701	996510011311	INFRARED RECEIVER RIGHT ANGLE
SW701	996500039269	TACT SWITCH
SW702	996500039269	TACT SWITCH
SW703	996500039269	TACT SWITCH
SW704	996500039269	TACT SWITCH
SW705	996500039269	TACT SWITCH
SW706	996500039269	TACT SWITCH
SW707	996500039269	TACT SWITCH
SW708	996500039269	TACT SWITCH
SW709	996500039269	TACT SWITCH
SW710	996500039269	TACT SWITCH
SW711	996500039269	TACT SWITCH
SW712	996500039269	TACT SWITCH

HEADPHONE PCB ASSY

HP901	994000001456	STEREO HEADPHONE JACK
HP902	996510001073	EARPHONE CKX3.5-19S (3PIN)

RECTIFIER PCB ASSY (ONLY FOR REFERENCE)

D102	996510011332	DIODE 1N4148
D212	996510011339	DIODE 1N4003
D303	996510011332	DIODE 1N4148
F101	△ 996510000389	FUSE 2.5A 250V
F102	△ 994000003224	FUSE 6.3A 250V
Q101	996510025112	TRANSISTOR BC547B
RL101	△ 994000003227	9V DC RELAY 10A
T101	△ 996510001418	TRANSFORMER STANDBY EI-28
T104	994000003226	AC LINE FILTER 400UH -30%
ZD102	996510011336	ZENER DIODE 7V5 1/2W (TC7V5)
T102	△ 996510025771	POWER TRASFO EI-66 230V/50Hz
